

the linear lighting people

mmj
lighting 96 ltd



stepping up to green

mmj lighting 96 ltd now has a complete line of recessed step and handrail lighting.

Handrail lighting is available for interior and exterior IP68 applications.

Incorporating light sources such as:

LV SMD Led modules:

: From 0.24w to 1.0w and standard spacing from 2.0" to 6.0" or CUSTOM spacing on request.

: And beam spreads from: 15 degrees to 60 degrees

LV Led SMD flex tape light™®

Our LV SMD LED flexible tape™® is now available up to:

12.0w per foot – 40w per meter using high brightness SMD Led's.

Including colour temperatures of: white and warm white

Single colour's of: **RED, GREEN, BLUE** and **YELLOW** to suit your various applications.

Our **LV Led flex tape light™®** offers 50,000 hours LV SMD Led life.

Lighting for many applications with minimal space and extremely flexible requirements.

LV LED SMD flex tape light™® is DIMMABLE using remote power supplies.....

Including EXTRUSIONS to enhance and conceal the LV Led flex tape light™ within many applications.

LV SMD LED flex tape light™® is Modular in sections from: 1.0'–39.37 meter up to: 16' 4"–54.12 meters

and can be easily installed and replaced when necessary.

and specialty applications consisting of:

: IP67 for damp locations

: IP68 for wet locations contact mmj96.

In addition to the above the mmj96 LV LED RGB flex™® is now available in full colour change.

The **RGB** colour change feature and our **COLOURSUM** controller allows the LV LED flex tape™® to bring multiple colours and colour change flexibility to your applications.

For further information contact your local mmj96 lighting representative:

150 ferrier street, unit 2, markham, ontario L3R 3K3
T 905 479 0788 F 905 479 7117 E sales@mmjlighting96.com

www.mmjlighting96.com

mmj
lighting 96 ltd

shop drawing

project specification

fixture type

D116-2.0-HR Stainless Steel Hand Rail Extrusion

Job Name:
Job Nbr:
Tag:
Distributor:
Electrician
Engineer:
Interior Design:
Architect:

Note:
Any Changes or modifications to mmj lighting 96 ltd lighting fixtures, must be done in the mmj lighting 96 ltd factory. Any modifications or changes done in the field will void all warranties and approvals.

note: **dimensioned drawings and site measurements required**

LV LED and LVT5 Hand Rail

TYPICAL: SPECIFICATIONS and DETAILS:

Lighting extrusion: D116-2.0" dia

Lens: D116L

Lighting: LVT5

LV Led

Power supply: integral

remote

Mounting: posts are provided to a maximum of 8' o.c. wall brackets are provided up to 6' o.c.

NOTE: upright spacing subject to site conditions. consult: mmj96.



stepping up to green

Hand rail:

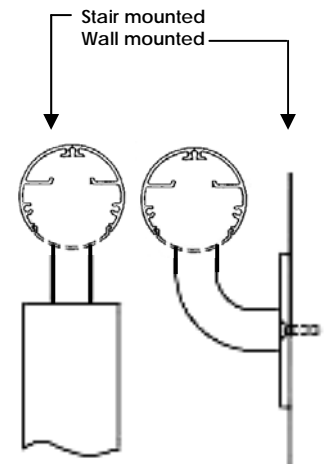

2.0" OD [0.60" wall]

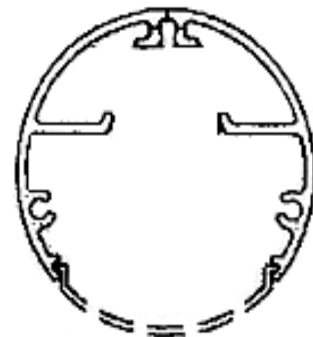

D116-2.0 - HR
Hand rail extrusion

Project Specification

Application: 72 linear feet of illuminated hand rail.

Finish: Stainless Steel

Lighting: LV SMD Led:

Colour temperature. warm white –

LV Led output: 7.6w p/' high output

Power supplies: TRD____ 350mA, 700mA

Estimated quantity required: 7 only power supplies.

Note: site measurements required for accurate power supply/enclosure quantities.

Estimated site conditions:

72' of wall mounted hand rail.

Estimated lengths to be: 4 x 12 linear feet each installed on a 30° slope, with returns to wall.

One section of approximately 24' with pipe rail ends that return to the wall.

Hand rail is to be fabricated from Stainless Steel material.

All covers, mounting accessories finished to match.

Internal sleeves and epoxy supplied with order.



D116-2.5-HR hand rail extrusion 11.29.08 C US

150 ferrier street, unit 2, markham, ontario L3R 3K3
T 905 479 0788 F 905 479 7117 E sales@mmjlighting96.com

www.mmjlighting96.com

mmj
lighting 96 ltd

shop drawing

project specification	In wall step light series
Fixture type:	D525.1 – D525.6 – D525.7 in wall LV Led starbrite™

Job Name:
 Job Nbr:
 Tag:
 note: site measurements required

Note:
 Any Changes or modifications to mmj lighting 96 ltd lighting fixtures, must be done in the mmj lighting 96 ltd factory. Any modifications or changes done in the field will void all warranties and approvals.

keeping in step
 with green



D525-1

Sq: 090mm - 3.55"
 D: 057mm - 2.25"
 Skt: LED

description:

- stainless steel face plate
- powder coated face plate available.
- aluminum body
- plastic housing with spring clip
- lens- hi-impact opal

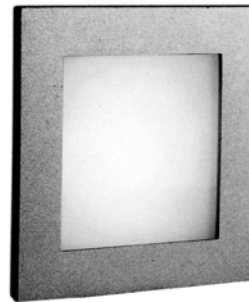

D525-6 stainless steel

Sq: 090 mm - 3.55"
 D: 057 mm - 2.25"
 Skt: LED

description:

- stainless steel face plate
- powder coated face plate available.
- aluminum body
- plastic housing with spring clip
- lens- hi-impact opal

fixture number	LV Led	cut off	power supply
<input type="checkbox"/> D525-6	<input type="checkbox"/> D199LED.1w	110	350mA remote
<input type="checkbox"/> D525-6	<input type="checkbox"/> D199LED.3w	110	700mA remote
<input type="checkbox"/> D525.6.retro	<input type="checkbox"/> D199LED.1w	110	350mA integral
<input type="checkbox"/> D525.6.retro	<input type="checkbox"/> D199LED.3w	110	700mA integral

D525-7 aluminum integral louvers

Sq: 090 mm - 3.55"
 D: 057 mm - 2.25"
 Skt: LED

description:

- aluminum face plate
- powder coated face plate available.
- aluminum body
- plastic housing with spring clip
- lens- hi-impact opal

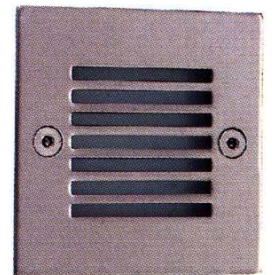

fixture number	LV Led	cut off	power supply
<input type="checkbox"/> D525.1. retro	<input type="checkbox"/> D199LED.1w	70	350mA integral
<input type="checkbox"/> D525.1. retro	<input type="checkbox"/> D199LED.3w	70	700mA integral
<input type="checkbox"/> D525.1. retro	<input type="checkbox"/> D199LED.1w	70	350mA integral
<input type="checkbox"/> D525.1. retro	<input type="checkbox"/> D199LED.3w	70	700mA integral



D525.1 – D525.6 – D525.7 series

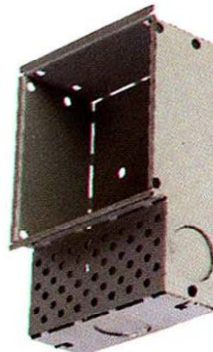

D525 housing less trim

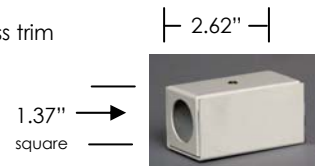

D139bx
 hardware box
 OPTIONAL

150 ferrier street, unit 2, markham, ontario L3R 0Y1
 T 905 479 0788 F 905 479 7117 E sales@mmjlighting96.com

www.mmjlighting96.com

mmj
 lighting 96 ltd

project specification	LV LED flex power supplies and Extrusions
fixture type	

power supplies:

ET6012M, ET7512M, ET10012M, ET15012M

Specifications:	length	width	height	watts	secondary	primary
<input type="checkbox"/> ET 6012M	8.5"	4.5"	1.50"	60w	12v	120v-5t
<input type="checkbox"/> ET 7512M	5.1"	3.8"	1.50"	75w	12v	120v-50/60HZ
<input type="checkbox"/> ET 10012M	6.3"	3.8"	1.50"	100w	12v	120v-50/60HZ
<input type="checkbox"/> ET 15012M	7.8"	3.9"	1.50"	150w	12v	120v-50/60HZ

Specifications:	length	width	height	watts	secondary	primary
<input type="checkbox"/> ET 32012M	8.5"	4.5"	1.50"	320w	12v	120v-50/60HZ

Dimmable power supplies:

<input type="checkbox"/> LV Led Mag100	6.48"	2.59"	2.33"	100w	12v	120v-60hz
<input type="checkbox"/> LV Led Mag 50	5.63"	2.14"	2.0"	50w	12v	120v-60hz

Note:

Housing includes wiring enclosure for 120v and 12v terminals .
Dimensions as noted above.
C-UL and UL Approved.[power supply listed 7D 53]

Note: This power supply is to be installed with mmj lighting 96 ltd lighting products as a component completing the C-US approval

ELECTRICAL INSTALLATION INSTRUCTIONS SUPPLIED BY: MMJ LIGHTING 96 LTD , MUST BE FOLLOWED.FAULTURE TO DO SO WILL VOID ANY APPROVALS.



ET 32012M

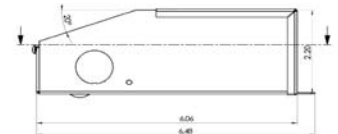
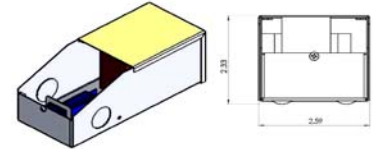

LV Led Mag50 / LV Led Mag 100

extrusions:

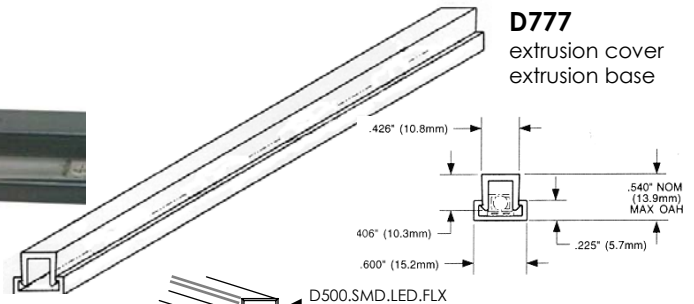

D777
extrusion cover
extrusion base

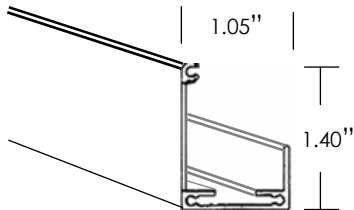

D121
full reflector

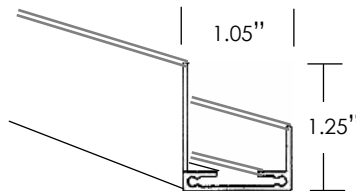

D121.1
3/4 reflector

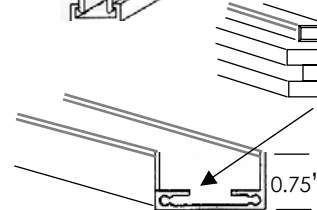

D121.2
low extrusion

D121.1
Insert for LV SMD LED FLX for ease of installation and replacement

D121c lens
 D121.1 D121.2
D121c lens
not illustrated

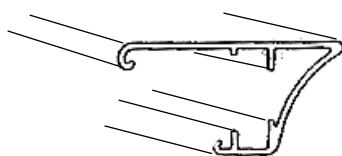

D119.D
beveled front reflector
under a shelf

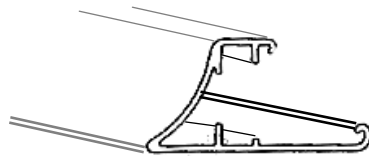

D119.U
beveled front reflector
above a cabinet

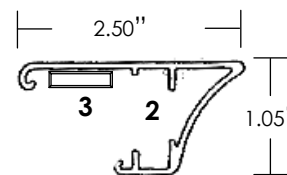

1. branch through wire access
2. integral power supply.
3. LV LED. Flex strip



LV LED FLX power supplies and extrusion page three c us