

the linear lighting people

mmj

green and flexible



**mmj lighting 96 ltd** has developed an improved **LV Led SMD flexible tape light™®**

Our LV SMD LED flexible tape™® is now available up to:

**12.0w per foot – 40w per meter** using high brightness SMD Led's.

Including colour temperatures of: white and warm white

Single colour's of: **RED**, **GREEN**, **BLUE** and **YELLOW** to suit your various applications.

Our **LV Led flex tape light™®** offers 50,000 hours LV SMD Led life.

Lighting for many applications with minimal space and extremely flexible requirements.

**LV LED SMD flex tape light™®** is **DIMMABLE** using remote power supplies.....

Including **EXTRUSIONS** to enhance and conceal the LV Led flex tape light™ within many applications.

**LV SMD LED flex tape light™®** is Modular in sections from: 1.0'–39.37 meter up to: 16' 4"–54.12 meters and can be easily installed and replaced when necessary.

: **Cove lighting** - up to 12w/12vDC per foot – 40w/12vDC per meter and an ideal replacement light source for COLD CATHODE.

In addition to:

: **Showcase and Display lighting**

: **Under and above cabinet lighting**

: **Closet rod lighting**

and specialty applications consisting of:

: **IP67** for damp locations

: **IP68** for wet locations contact mmj96.

In addition to the above the mmj96 LV LED RGB flex™® is now available in full colour change.

The **RGB** colour change feature and our **COLOURSUM** controller allows the LV LED flex tape™® to bring multiple colours and colour change flexibility to your applications.

For further information contact your local mmj96 lighting representative:

150 ferrier street, unit 2, markham, ontario L3R 3K3  
T 905 479 0788 F 905 479 7117 E sales@mmjlighting96.com

[www.mmjlighting96.com](http://www.mmjlighting96.com)

mmj  
lighting 96 ltd

# shop drawing

project specification **D500LED.FLX.SC™@** single colour – **D500LED.FLX.IP68 gel filled™@**

fixture type

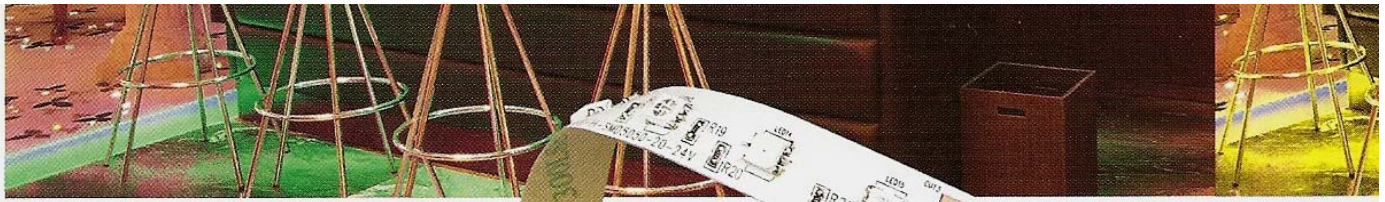

green and flexible

single colour  
ordering guide

**LV SMD Led LV LED spacing:** 0.629" o.c. – 12vdc – 18 smd Led's per foot.

**Standard single colour:** 0.12w 12vDC each **High Brightness single colour:** 0.24w 12vDC each

**SC: single colour:**  White  Warm White  Red  Blue  Green  Yellow

**Dimensions:** 0.394" wide x 0.098" high

**Cutting point:** 1.907" o.c. – as indicated on light strip

**Maximum run:** 16.4" – 5 meters = 36w@12vDC=3.0a - 2.2w per foot STANDARD COLOUR  
16.4" – 5 meters = 80w@12vDC=7.0a - 5.0w per foot HIGH BRIGHTNESS

**Mounting:**  
a. two sided tape  
b. extrusion – refer to page 4

### Ordering Guide:

**D500LED.FLX™@:**

se - single ended de - double ended

### Standard Brightness: 2.2w per foot:

- D500LED.FLX.SE** – 16.40' 5.0 meters SE – 2.2w p' = 36w-12vDC
- D500LED.FLX.DE** – 8.20' 2.5 meters DE – 2.2wp' = 18w 12vDC
- D500LED.FLX.DE** – 4.10' 1.25meters DE – 2.2wp' = 9w 12vDC
- D500LED.FLX.DE** – 2.05' 1.025meters DE - 2.2wp' = 5w 12vDC

### High Brightness: 5.0w per foot:

- D500LED.FLX.SE.HB** 16'4" 5.0 meters SE – 5.0w p' = 82w – 12vDC
- D500LED.FLX.DE.HB** 8'2" 2.5 meters DE – 5.0w p' = 41w - 12vDC
- D500LED.FLX.DE.HB** 4'1" 1.25 meters DE – 5.0wp' = 20.5w 12vDC
- D500LED.FLX.DE.HB** 2'5" 1.025 meters DE - 5.0wp' = 10.0w 12vDC

**Wet Location: IP68 - CONSULT MMJ96**

### Special WET applications:

- D500LED.FLX.IP68** factory terminated gel filled light strip
- D500LED.FLX.IP68.PF2** four pin power feed with shrink
- D500LED.FLX.IP68.JF2** four pin joiner with shrink

**note:** all terminations must be prepared at the mmj lighting 96 ltd factory  
Shrink connections can be installed in the field

### Accessories:

#### D500LED.FLX™@. power feeds:

- D500LED.FLX.PF2** – two wire power feed with 12" tail

**Note:** power feed tails can be custom lengths  
consult mmj96 – **NOT INCLUDED**

#### D500LED.FLX™@. Joiner:

- D500LED.FLX.JF2** – four pin joiner

**Power supply:** SHOP DRAWING PAGE 3 of 3

**Extrusions:** SHOP DRAWING PAGE 3 of 3

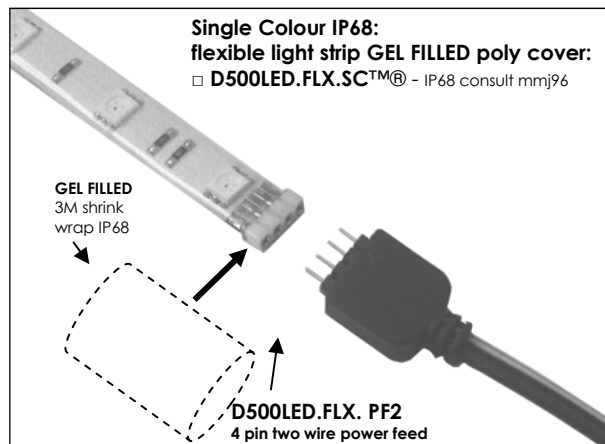
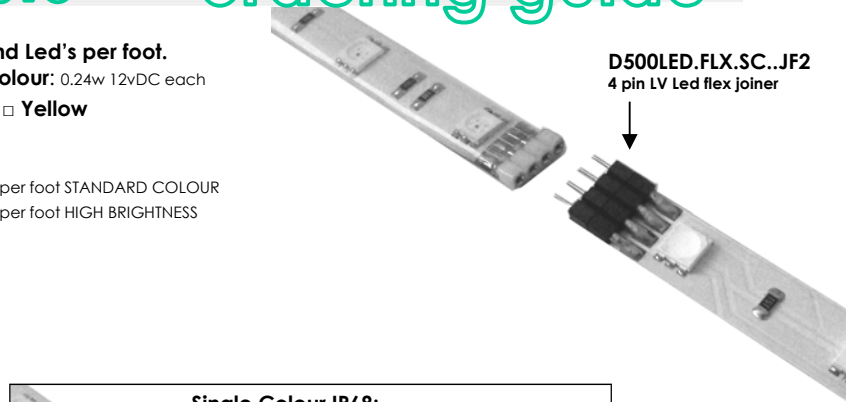

D500LED-D121.FLX D121 shop drawing 10.25.09  
c RU us approved

**Note:**  
Any Changes or modifications to mmj lighting 96 ltd lighting fixtures, must be done in the mmj lighting 96 ltd factory. Any modifications or changes done in the field will void all warranties and approvals.

Job Name:  
Job Nbr:  
Tag:  
note: site measurements required  
Dated:  
Accepted:

150 ferrier street, unit 2, markham, ontario L3R 3K3  
T 905 479 0788 F 905 479 7117 E sales@mmjlighting96.com

www.mmjlighting96.com

**mmj**  
lighting 96 ltd

# shop drawing

project specification:

**D500LED.FLX.RGB™@**

fixture type:

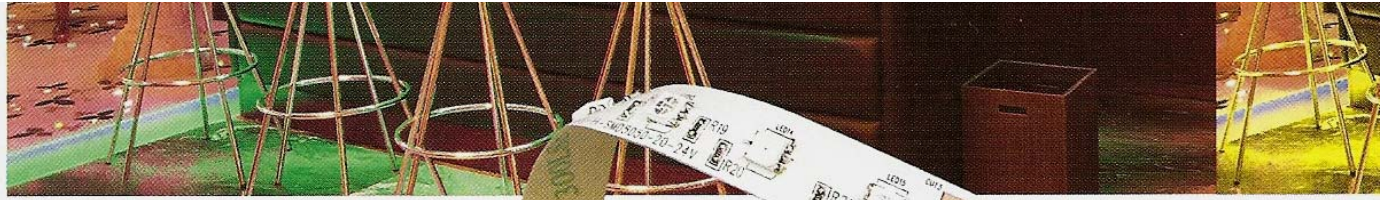

rgb

green and flexible

ordering guide



D500LED.FLX.RGB.DE

D500LED.FLX.RGB.PF2  
4 pin 4 wire Power feed

C450.RGB.DMX

C450.DMX.R

Full function remote  
For small applications

### flexible light strip poly cover:

- D500LED.FLX.RGB™@ - IP68 gel filled
- D500LED.FLX.RGB™@ - IP65
- D500LED.FLX.RGB™@ - IP33

### C145.RGB for larger projects:

- : COLOURSUM RGB DMX
- : Full dim function
- : Controls speed, fader and chase.
- : Colour blending, Scenes and Patterns
- Contact mmj96

### RGB: colour change LV Led – 50,000 hours full colour range:

red: 620-630K,

green: 520-530K

blue: 460-470K

beam angle: 110°

voltage: 12vDC

Watts: 6.72w/m

LV Led: RGB-SMD – 800 lumens p/m

spacing: 0.761" o.c – 9.14 SMD LED's per foot

dimensions: 0.546" width x 0.198" height

Cutting point: 3.885" o.c.

Maximum run: 16.4" – 5 meters

Mounting: two sided tape

### LV SMD RGB Led Ordering Guide:

#### D500LED.FLX.RGB™@ – 12v

se: single ended – de: double ended

- D500LED.FLX.RGB.SE - 16.40'-5.0 meters SE
- D500LED.FLX.RGB.DE - 8.20'-2.5 meters DE
- D500LED.FLX.RGB.DE - 4.10'-1.25 meters DE
- D500LED.FLX.RGB.DE - 2.05'-1.025 meters DE

### IP rating – specify:

- IP 33
- IP 65
- IP 68 Note: IP68 available on request – contact mmj96

### Accessories:

#### D500LED.FLX™@ power feeds:

- D500LED.FLX.PF4 – four wire power feed

#### D500LED.FLX™@ joiner:

- D500LED.FLX.JF4 – four wire joiner

Power supply: refer to page 4

Extrusions: refer to page 4.

D500LED-D121.FLX D121 shop drawing 10.25.09  
C RU us approved

150 ferrier street, unit 2, markham, ontario L3R 3K3  
T 905 479 0788 F 905 479 7117 E sales@mmjlighting96.com

www.mmjlighting96.com

mmj  
lighting 96 ltd

project specification LV LED flex power supplies and Extrusions

fixture type

## power supplies:

### ET6012M, ET7512M, ET10012M, ET15012M

Specifications:	length	width	height	watts	secondary	primary
□ ET 6012M	8.5"	4.5"	1.50"	60w	12v	120v-5t
□ ET 7512M	5.1"	3.8"	1.50"	75w	12v	120v-50/60HZ
□ ET 10012M	6.3"	3.8"	1.50"	100w	12v	120v-50/60HZ
□ ET 15012M	7.8"	3.9"	1.50"	150w	12v	120v-50/60HZ

Specifications:	length	width	height	watts	secondary	primary
□ ET 32012M	8.5"	4.5"	1.50"	320w	12v	120v-50/60HZ

### Dimmable power supplies:

□ LV Led Mag100	6.48"	2.59"	2.33"	100w	12v	120v-60hz
□ LV Led Mag 50	5.63"	2.14"	2.0"	50w	12v	120v-60hz

### Note:

Housing includes wiring enclosure for 120v and 12v terminals .  
Dimensions as noted above.

C-UL and UL Approved.[ power supply listed 7D 53]

**Note:** This power supply is to be installed with mmj lighting 96 ltd lighting products as a component completing the C-US approval

ELECTRICAL INSTALLATION INSTRUCTIONS SUPPLIED BY: MMJ LIGHTING 96 LTD , MUST BE FOLLOWED.FAULTURE TO DO SO WILL VOID ANY APPROVALS.



ET 32012M

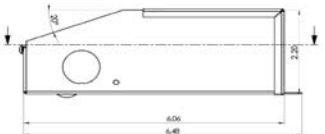
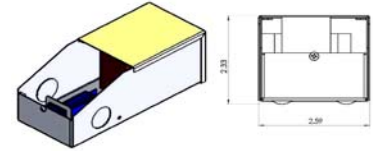

LV Led Mag50 / LV Led Mag 100

## extrusions:

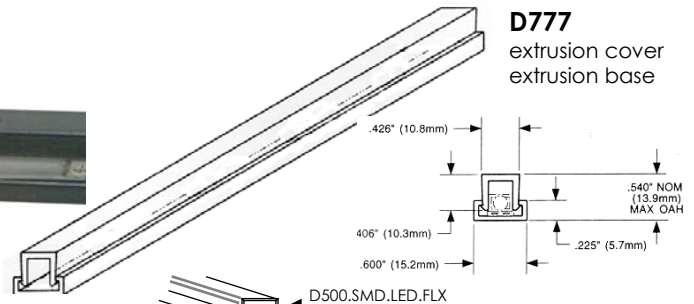

**D777**  
extrusion cover  
extrusion base

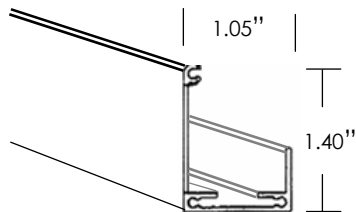

□ **D121**  
full reflector

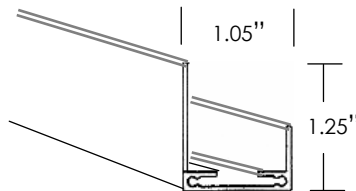

□ **D121.1**  
3/4 reflector

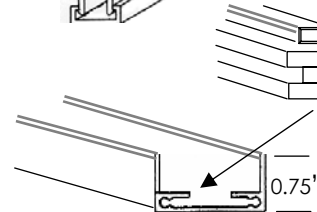

□ **D121.2**  
low extrusion

**D121.1**  
Insert for LV SMD LED FLX for ease of installation and replacement

**D121c lens**  
□ D121.1 □ D121.2  
**D121C lens**  
not illustrated

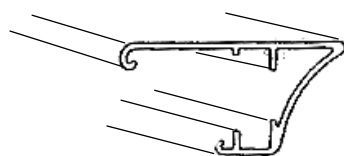

**D119.D**  
beveled front reflector  
under a shelf

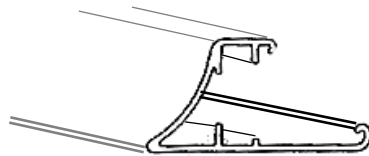

**D119.U**  
beveled front reflector  
above a cabinet

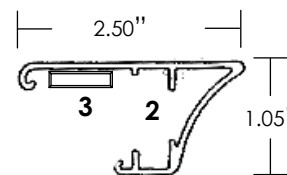

1. branch through wire access
2. integral power supply.
3. LV LED. Flex strip



LV LED FLX power supplies and extrusion page three c us